



CAPACITY • HIGH-PRECISION • SPECIALTY • HONESTY



公司簡介

本公司成立於西元1965年10月，致力於研發與專業製造汽車之零組件已達50餘年，自成立以來本公司即不斷擴充自動化生產設備及檢測儀器，以生產高品質、高精密及高效能之汽車零件為職志。目前本公司之主要客戶涵蓋世界各國，主要產品有水邦浦、動力方向機、油壓邦浦、空壓零件、離合器系統、煞車系統...等

自1997年起，本公司為求永續經營且要求突破目前之技術層次，開始研發高效率、低噪音、重環保之「渦輪增壓器」。於西元2000年4月成功的推出第一款 **CHSH** 品牌渦輪增壓器。

本項「渦輪增壓器」不僅經過嚴格檢測及品管的層層把關，更經國家最高工業技術研究院檢測合格並給於高度肯定。且就目前國內製造業技術而言，尚無任何廠家開發此類產品，因此在經濟部2001年「鼓勵中小企業開發新技術推動計畫」本公司以「往復式引擎渦輪增壓器研究開發」獲得經濟部之研究獎勵。更於2002年底榮獲經濟部推選為績優廠商，特頒予「星耀獎」加以表揚與肯定。

我們歷經五十多年之企業成長與不斷升級，完全憑藉著本公司一貫的企業文化與經營理念：

CAPACITY 能力

自動化的生產設備及電腦化的製程控制

HIGH-PRECISION 高精密

各項精密量測儀器及100%品質管制

SPECIALTY 專業

豐富的經驗及不斷革新之研發技術

HONESTY 誠實

誠信待人實在做事

未來本公司將繼續秉持著高精密度與不斷創新的原則，開發規格齊全之「渦輪增壓器」尋求理想合作夥伴，共創21世紀雙贏的策略。



COMPANY PROFILE

The CHIH SHENG FACTORY CO.,LTD.(CHIAU CHENG) was established in Oct.1965 and has been devoted to the development of automotive parts and systems for over 50 years. In fact, we have been building and contributing the remarkable efforts to enhance our capabilities for generating the superior quality, great leading precision and efficient automotive parts by acquiring advanced automated machinery and testing equipment continually. Our main products include Water Pump System, Hydraulic Pump System, Air Compressor System, Clutch Booster System, and Air Brake System...etc.

Since 1997, with an aim to be international and competitive particularly in the global market. We have undoubtedly launched a program to form and progress the more functions of turbocharger with additional utilities such as high efficiency, environmental friendly and diminution in volume,and then successfully introduced the first generation of **CHSH** brand Turbocharger in April 2000.

Our turbocharger not only meets all the strict testing and quality requirements, also has been qualified and positively praised by the "Industrial Technology Research Institute (ITRI)", which has been acknowledged as one of the top industrial technology research organizations in Taiwan. Indeed,we are currently the only company which having this unique industrial capacity of producing such type of products in Taiwan! Additionally, our developing program of turbocharger was awarded and subsidized by the "SBIR" program launched by the Ministry of Economic Affairs which also mainly encourages small business to engage in product development. Furthermore, we have also been selected the best qualified business enterprise by Ministry of Economic in the end of 2002 and awarded "Star Luminescent Award" as the recognition and affirmation for our recent achievement.

With the purpose of being more successful, there are four basic principles which significantly adopted and completely practiced as the parts of CHSH's long-term business developing strategies:

CAPACITY

Realization of production automation and computerized manufacturing process control.

HIGH-PRECISION

Utilization of high-end testing equipment as well as advanced quality control methods.

SPECIALTY

Be experienced, professional and innovative in technology development continually.

HONESTY

Honesty is constantly being one of the key concerns as the internal and external industrial spirit and attitude to the clients.

In the future, via applying the four main approaches above for CHSH's further innovating and developing high-precision products and all ranges of turbochargers persistently and certainly, discovering the appropriate partnership and creating the "Win-Win" aspect for both or more cooperating parties in order to benefit and satisfy all the clients needs.

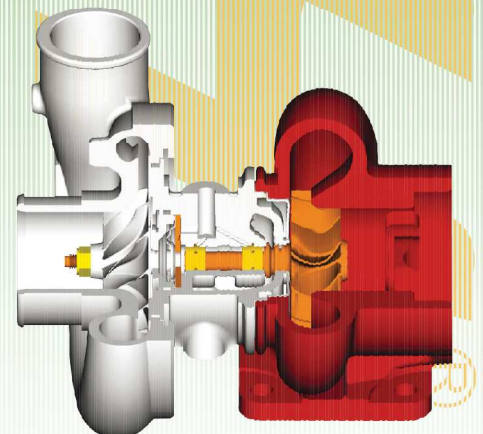

自動化生產設備 - AUTOMATIC PRODUCING EQUIPMENT

自動化生產設備 - Automatic Producing Equipment

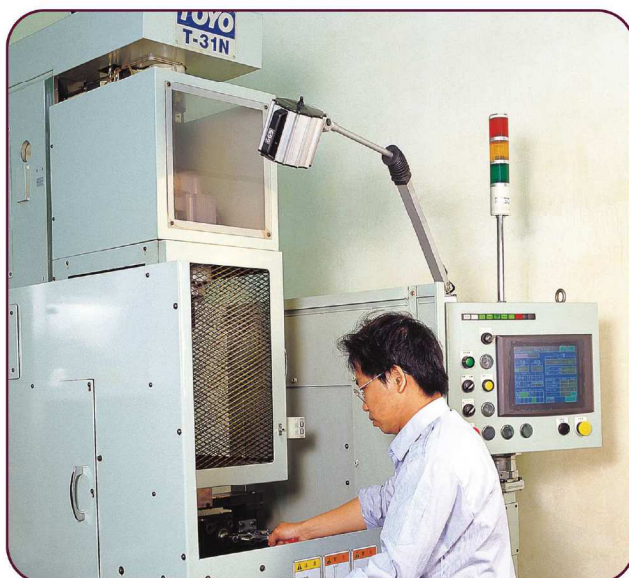

動平衡檢驗設備 - Balance Test Equipment

動平衡檢驗設備 - BALANCE TEST EQUIPMENT



精密測量儀器 - PRECISE MEASURING INSTRUMENT

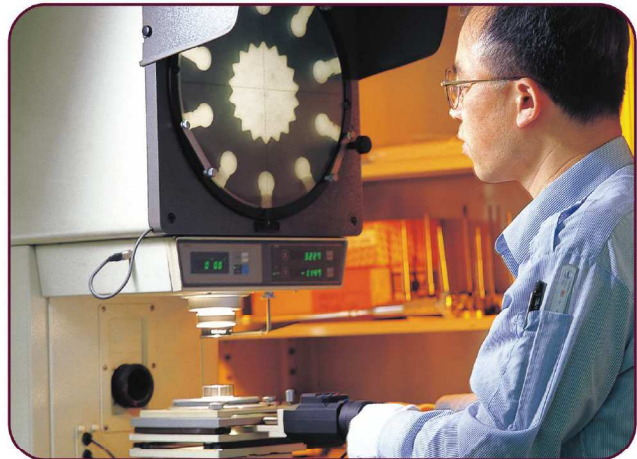

精密測量儀器 - Precise Measuring Instrument

渦輪增壓器設計 / 製造 / 測試 - TURBOCHARGER DEVELOPMENT

渦輪增壓器設計 / 製造 / 測試 - Turbocharger Development

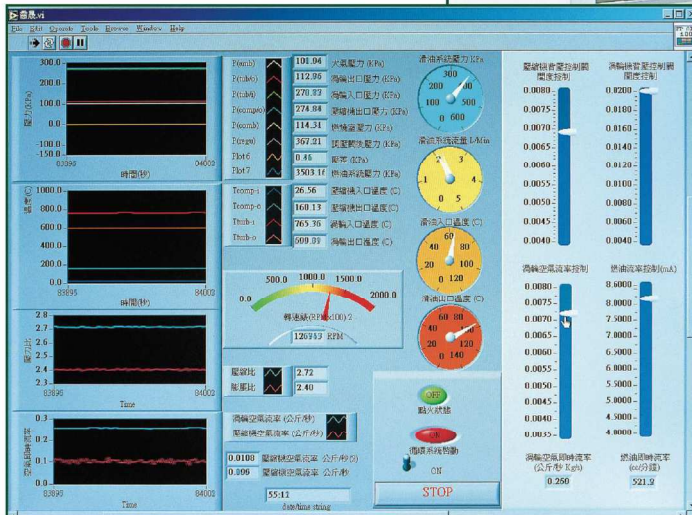
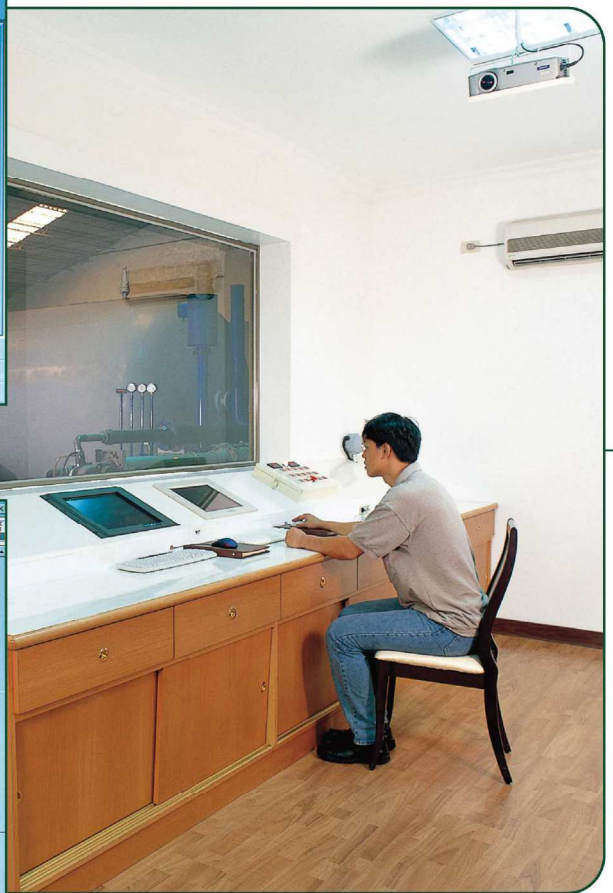
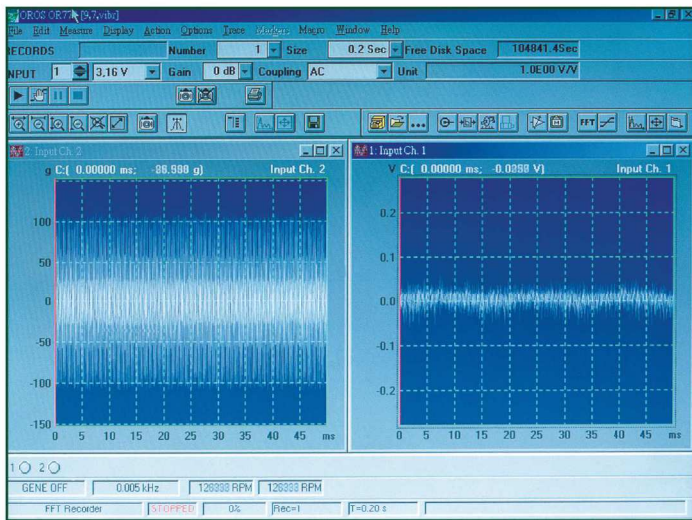
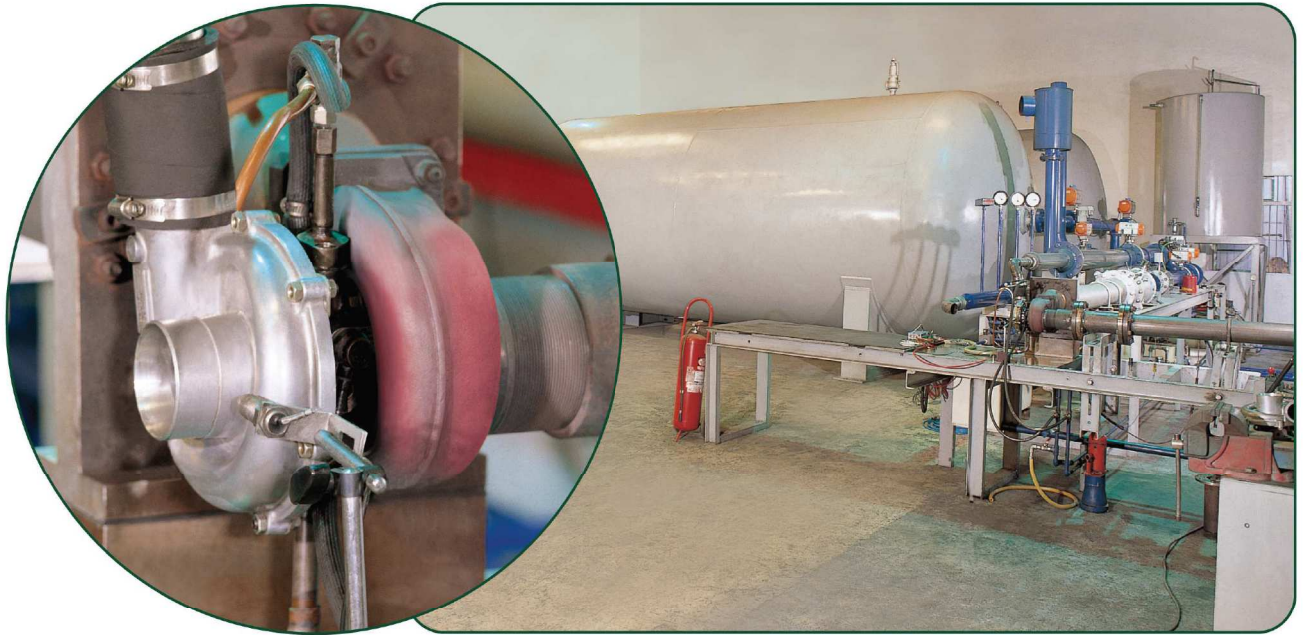

實驗室特性：

1. 國內第一座渦輪增壓器性能測試暨數據平台。
2. 測試能量涵蓋世界上所有廠牌產品，壓縮比 0~5；流量範圍 0~2kg/sec。
3. 網際網路遙控遙測系統。

Laboratory Characteristics:

1. The first Local Turbocharger Performance Tester and Digital Platform.
2. The Test Capacity covers all the brands in the world with the Compression Rate 0~5 ; flow capacity range 0~2 kg/sec.
3. Internet Remote Control System.

Specifications

Model	TD02	TD025	TD03	TD04	TD05	TD06	TD07	TD08
Max. Speed rpm	270000	250000	230000	200000	170000	145000	132000	114000
Max. Gas Temperature °C	900	900	900	900	900	900	760	760
Max. Pressure Ratio	2.2	2.2	2.3	2.4	2.6	2.7	2.8	3.1
Weight kg	without W/G*	—	3.0	3.5	4.0	5.0	9.0	10.5
	with W/G*	2.0	2.3	3.5	4.0	5.0	—	—

• W/G* : Waste Gate Valve System

• Specifications subject to change without prior notice.

Pressure Ratio

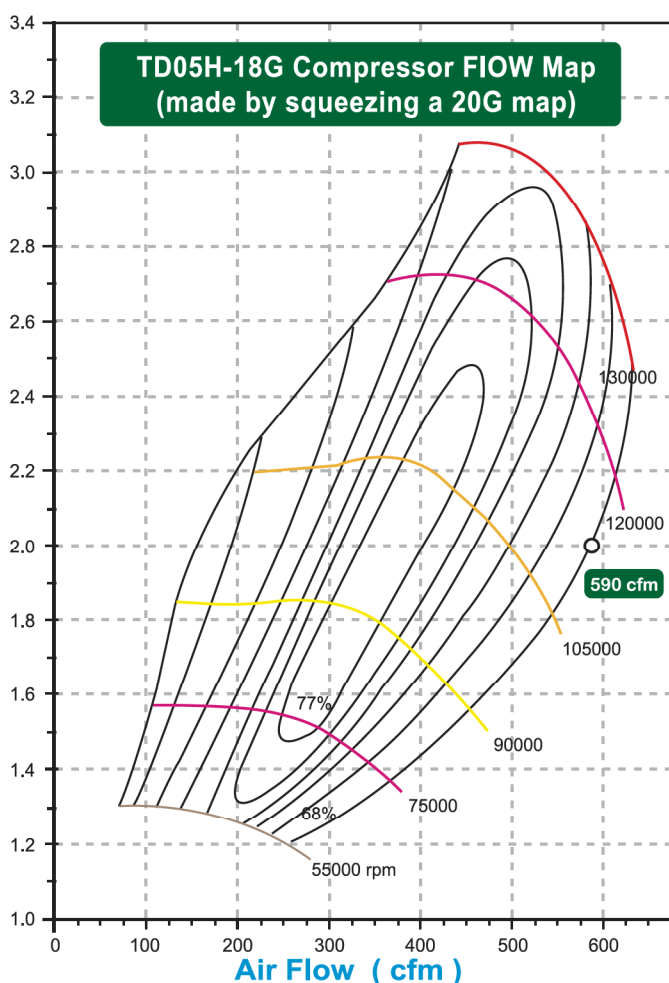

技術特點與技術應用範圍描述

特點：

1. 渦輪機械設計，分析技術（實驗室）。
2. 葉輪鑄造技術。
3. 渦輪機械測試平台設計技術（整廠）。
4. 內燃機引擎渦輪增壓。

The Description of The Technical Features and Technical Application Range

Characteristic :

1. Design and analysis of turbomachinery.
 2. Gas turbine blisc casting techniques.
 3. Test rig design for turbomachinery.
- Turbomachinery the internal combustion engine.

渦輪增壓器的基本知識 - TURBOCHARGER BASICS

渦輪增壓器是用來提高引擎功率和減少排放黑煙的重要部件。渦輪增壓器本身不是一種動力源，它利用引擎排氣中的剩餘能量來工作，其作用是向引擎提供更多的壓縮空氣。

Turbocharger is an important part used to increase the engine efficiency and to reduce black smoke exhaust discharge. The Turbocharger itself is not a power unit source; it works on left over energy from the engine exhaust to provide more compressed air to the engine.

在增壓中冷型發動機系統中，中冷器位於渦輪增壓器壓氣機的下流，其作用是降低壓縮空氣的溫度，從而進一步增加壓縮空氣的密度。

In a boosting cold start engine system, the charge air cooler, placed downstream from the turbocharger compressor, works to lower the temperature of and thereby increase the density of the compressed air.

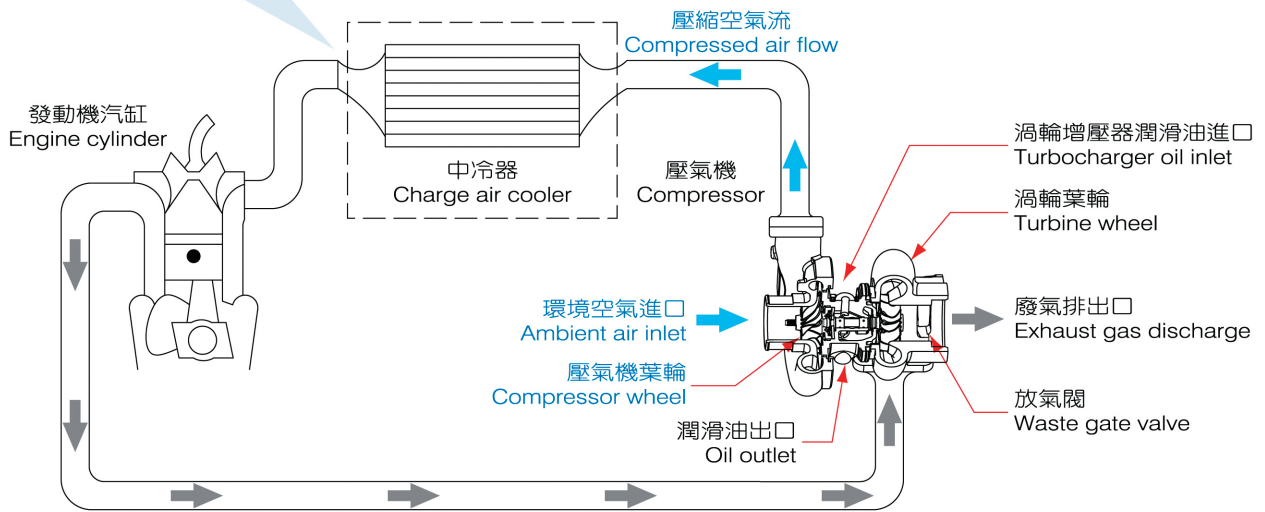

渦輪增壓器工作原理圖 - Illustration of Turbocharger Operating Principle

渦輪增壓器安裝在引擎排氣管上，引擎汽缸排出的廢氣推動渦輪葉輪轉動，再帶動壓氣機葉輪將經空濾器濾清的空氣加壓後送入氣缸。因為進入氣缸的空氣增多，所以允許噴入更多的燃油，使燃油更充分的燃燒，然而使引擎產生更大的功率或降低排放黑煙。渦輪增壓器還可使引擎在高原上工作時獲得功率補償。

Turbocharger is installed on the exhaust manifold of the engine. The exhaust from the engine cylinder causes the turbine wheel to spin, which then causes the compressor wheel to compress air, filtered through the air filter, to send to the cylinder. The increase of air into the cylinder allows for more fuel injection; fuel burns more efficiently and the engine produces more power along with a reduced amount of black smoke exhaust. The Turbocharger also compensates power when the engine is operating at higher altitudes.

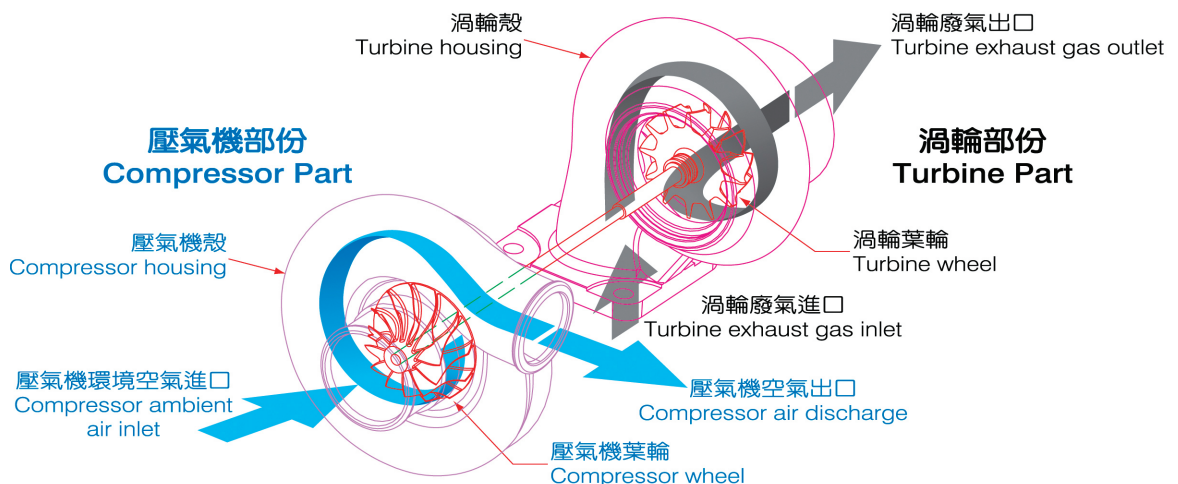

PERFORMANCE TURBOCHARGERS

SUBARU GC 8



Models	Turbine		Compressor		Max HP	Application
	Wheel	Diameter (mm)	Wheel	Diameter (mm)		
S5167	TD05H	49.2 / 56	16 G	48.3 / 68	380	EJ20 IMPREZA WRX STI
S5187			18 G	50.5 / 68	400	
S5207			20 G	52.6 / 68	430	
S6167	TD06SL2	54.08 / 61	16 G	48.3 / 68	380	
S6187			18 G	50.5 / 68	400	
S6207			20 G	52.6 / 68	430	
NOZZLE AREA 7 CM ²			A / R 49		Actuator 0.9 BAR	

SUBARU GC 8



Models	Turbine		Compressor		Max HP	Application
	Wheel	Diameter (mm)	Wheel	Diameter (mm)		
S5188	TD05H	49.2 / 56	18 G	50.5 / 68	420	EJ20 IMPREZA WRX STI
S5208			20 G	52.6 / 68	450	
S6188	TD06SL2	54.08 / 61	18 G	50.5 / 68	420	
S6028			20 G	52.6 / 68	450	
NOZZLE AREA 8 CM ²			A / R 57		Actuator 0.9 BAR	

UNIVERSAL



Models	Turbine		Compressor		Max HP	Application
	Wheel	Diameter (mm)	Wheel	Diameter (mm)		
U4156	TD04H	44 / 52	15 G	43.4 / 56	250	T25 /28 FLANGE
NOZZLE AREA 6 CM ²			A / R 41		Actuator 0.4 BAR	

EVOLUTION IV-VIII
MITSUBISHI



Models	Turbine		Compressor		Max HP	Application
	Wheel	Diameter (mm)	Wheel	Diameter (mm)		
M5167	TD05H	49.2 / 56	16 G	48.3 / 68	380	4G63 EVO III ECLIPSE VR4
M5187			18 G	50.5 / 68	400	
M5207			20 G	52.6 / 68	430	
M6167	TD06SL2	54.08 / 61	16 G	48.3 / 68	380	
M6187			18 G	50.5 / 68	400	
M6207			20 G	52.6 / 68	430	
NOZZLE AREA 7 CM ²			A / R 49		Actuator 0.8 BAR	

EVOLUTION IV-VIII
MITSUBISHI



Models	Turbine		Compressor		Max HP	Application
	Wheel	Diameter (mm)	Wheel	Diameter (mm)		
M5160	TD05H	49.2 / 56	16 G	48.3 / 68	380	4G63 EVO IV-VIII
M5180			18 G	50.5 / 68	400	
M5200			20 G	52.6 / 68	430	
M6160	TD06SL2	54.08 / 61	16 G	48.3 / 68	380	
M6180			18 G	50.5 / 68	400	
M6200			20 G	52.6 / 68	430	
NOZZLE AREA 10.5 CM ²			A / R 58		Actuator 1 BAR	

PERFORMANCE TURBOCHARGERS

MITSUBISHI
EVOLUTION IX



Models	Turbine		Compressor		Max HP	Application
	Wheel	Diameter (mm)	Wheel	Diameter (mm)		
M5160U	TD05H	49.2 / 56	16 G	48.3 / 68	380	4G63 EVO9
M5180U			18 G	50.5 / 68	400	
M5200U			20 G	52.6 / 68	430	
M6160U	TD06SL2	54.08 / 61	16 G	48.3 / 68	380	
M6180U			18 G	50.5 / 68	400	
M6200U			20 G	52.6 / 68	430	
NOZZLE AREA 10.5 CM ²			A / R 49		Actuator 1 BAR	

MITSUBISHI
EVOLUTION IV X



Models	Turbine		Compressor		Max HP	Application
	Wheel	Diameter (mm)	Wheel	Diameter (mm)		
M5160R	TD05H	49.2 / 56	16 G	48.3 / 68	380	4G63 EVO10
M5180R			18 G	50.5 / 68	400	
M5200R			20 G	52.6 / 68	430	
M6160R	TD06SL2	54.08 / 61	16 G	48.3 / 68	380	
M6180R			18 G	50.5 / 68	400	
M6200R			20 G	52.6 / 68	430	
NOZZLE AREA 10.5 CM ²			A / R 49		Actuator 1 BAR	

UNIVERSAL



Models	Turbine		Compressor		Max HP	Application
	Wheel	Diameter (mm)	Wheel	Diameter (mm)		
U6208	TD06SL2	54.08 / 61	20 G	52.6 / 68	430	TRIANGLE FLANGE
NOZZLE AREA 8 CM ²			A / R 89		EXTERNAL WASTEGATE	

NISSAN SILVIA



Models	Turbine		Compressor		Max HP	Application
	Wheel	Diameter (mm)	Wheel	Diameter (mm)		
N5188	TD05H	49.2 / 56	18 G	50.5 / 68	400	T25 FLANGE SILVA S13, 14, 15 SR20DET
N5208			20 G	52.6 / 68	430	
N6188	TD06SL2	54.08 / 61	18 G	50.5 / 68	400	
N6028			20 G	52.6 / 68	430	
NOZZLE AREA 8 CM ²			A / R 57		Actuator 1 BAR	

GT2 WASTEGATE



Models

14005-AK002

Colors



DIESEL TURBOCHARGERS

MITSUBISHI



8DC91T (LH)
ME097476
49174-00592

MITSUBISHI



8DC91T (RH)
ME091427
49174-00593

MITSUBISHI



6D22T (90mm) 6D22T (98mm)
ME053934 ME053939
49174-01140 49188-01261

MITSUBISHI



6D16T
ME073573
49187-00270

MITSUBISHI



4D56T
49177-01515
MR355220

MITSUBISHI



S6KT/S4KT
517903
49179-00530

MITSUBISHI



4M40T
49135-03311

MITSUBISHI



4D34 (鋁葉小)
49178-02380 / ME014880

MITSUBISHI



4D34
49178-02340 / ME210143

MITSUBISHI



4D34
49178-02345 / ME212182
49178-02320 / ME014878

MITSUBISHI



TD13M-47B
49182-02111

KOMATSU



PC200-3 / S6D105
T04859-39 / T0413-59
6137-82-8200 / 465044-0261

DIESEL TURBOCHARGERS

KOMATSU



PC200-5 / S6D95
6207-81-8210
465044-0251

KOMATSU



PC300-5 / S6D108
6222-81-8210
466704-0203

KOMATSU



PC300-6 / SA6D108
466670-0013

HINO



K13C
24100-2085A
VH250015

HINO



K13C-TEL
24100-2920
3533261

HINO



EP1 (94mm) EP100 (90mm)
24100-1653A 24100-1397A

HINO



EP100 (90mm)
24100-1440C

HINO



HO7CT
24100-2850A
466063-0012

HINO



HO6CT
24100-2263A
VI240041

HINO



JO8C
24100-3251 / 479016-0002
150849-0001

HINO



6BG1TC
VB570031
1144003770

ISUZU



6BG1TC1
114002852
VC430089

DIESEL TURBOCHARGERS



ISUZU

6BD1T - 日立280型/C112
1-14400-107-0
VA150021



ISUZU

6BD1T - 日立EX200-1/C156
1-14400-210-0
NH170048



ISUZU

6BGD1TPJ - 日立EX200-2/C189
1-14400-272-0
VA240044



ISUZU

6SD1T
1-14400-339-3
VB730020



ISUZU

6HE1
8-94394-608-0
466515-0003



ISUZU

4JG2T
8-97212842-3



ISUZU

P11C VX881206 S1760-E0220A
24100-2750 / 24100-2751B
24100-2751 / 24100-2752



NISSAN

NE6T
14201-95010 / 14201-96671
466573-0001



NISSAN

PF6
14201-96607
466242-0016



NISSAN

PE6T
14201-96563

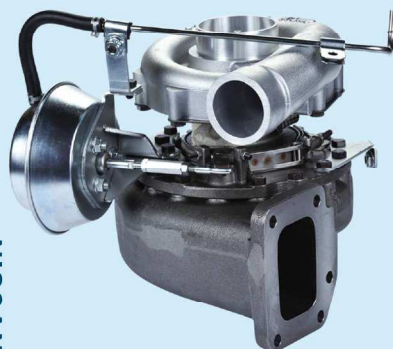

NISSAN

PF6VG (VNT)
14201-96764 / 466559-20
14201-96605



NISSAN

FE6TA / GT3576DL / PK260
14201-Z5905 / 702172-12
14201-Z5007

DIESEL TURBOCHARGERS

NISSAN



FE6T
14201-Z5715 / 702732-0001
14201-Z5772

TOYOTA



LANDCRUISER 1HD-FTE
(CT20B/CT12B)
17201-17040

TOYOTA



1HD-T / CT26
17201-17010 / 17201-17030
17201-17050

TOYOTA



13BT / 14BT / CT26
17201-58020

TOYOTA



WO4D/2KD-FTV
17201-0L030 / 17201-30030
17201-30120

TOYOTA



WO4D/2KD-FTV
17201-0L050 17201-30140
17201-30080

TOYOTA



DUTRO/N04C-TK
17201-78130/17201E0080
766237-0005

TOYOTA



DUTRO2/W04D
17201-E0680/786363-4

VOLVO



K26-3264MGA8.71GAAXB
53269706497/53269886497
AQAD41A/AD41P/TAMD41B/KAD42

SCANIA



HX50 / DSC12
3591167 / 3591985

SCANIA



HX50-2 / DSC11-21
3537639 / 4033155

SCANIA



HX55 / 124 / DC1201
4038616 / 570162
570873 / 1484886

DIESEL TURBOCHARGERS

MAZDA



J97A / WLT
VC430089
RHF5

CUMMIS



HX35W
4042739
4043249

CUMMIS



HE351W
4047759
4047760

MITSUBISHI



4M40/PAJERO
49135-03310

MITSUBISHI



4D56/L300/L400
49135-02210

DIESEL TURBOCHARGERS



TURBOCHARGER CARTRIDGE



TURBOCHARGER
CARTRIDGE

車輛廠牌 Brand	正廠號碼 OE-Part-No.	適用車種 Models
mitsubishi	49188-08120	8DC91T (LH & RH) 6D22T (90 mm & 98 mm)
mitsubishi	49187-08620	6D16T
mitsubishi	49177-08020	4D56
mitsubishi	—	S6KT/S4KT
mitsubishi	49135-08000	4M40T
komatsu	447450-0088	PC200-3
komatsu	447450-0084	PC200-5
benz	310225	BENZ
komatsu	447450-0079	PC300-5
komatsu	—	PC300-6
hino	—	K13C
hino	VA860014	EP100 (90 mm & 94 mm)/EP1
hino	445074-0019	HO7CT
isuzu	VA850013	6HE1
hino	—	HO6CT
hino	3580579	K13C-TEL
isuzu	VA830011	6BD1T - 日立 280 型
isuzu	VA860012	6BD1T - 日立 EX200-1
isuzu	VA850014	6BD1TPJ - 日立 EX200-2
isuzu	VAX30011	6SD1T
isuzu	—	4JG2T
nissan	447450-0057	NE6T
nissan	—	PF6
toyota	—	LANDCRUISER 1HD (CT20/CT26)
daihatsu	—	VQ29 (RHF3)
suzuki	—	VZ28 (RHF3)



TURBOCHARGER
KIT

TURBOCHARGER KIT

車輛廠牌 Brand	正廠號碼 OE-Part-No.	適用車種 Models
mitsubishi	49188-80200	8DC91T (LH & RH) 6D22T (90 mm & 98 mm)
mitsubishi	49187-80100	6D16T
mitsubishi	49177-80400	4D56
mitsubishi	49178-81110	S6KT/S4KT
mitsubishi	—	4M40T
komatsu	—	PC200-3 / PC200-5 / PC300-5 / PC300-6
benz	468100-0000	BENZ
hino	—	K13C / EP100 (90 mm & 94 mm)/EP1
isuzu	NH179859	6BD1T - 日立 EX200-1
hino	—	HO7CT
isuzu	NH169836	6HE1
hino	—	HO6CT
hino	3545653	K13C-TEL
isuzu	NH179810	6BD1T - 日立 EX280型
isuzu	—	6BD1TPJ - 日立 EX200-2
isuzu	—	6SD1T
isuzu	NH459801	4JG2T
nissan	467057-0001	NE6T
nissan	—	PF6
toyota	—	LANDCRUISER 1HD (CT20/CT26)
daihatsu	—	VQ29 (RHF3)
suzuki	—	VZ28 (RHF3)

HYDRAULIC PUMP SYSTEM



FUSO
6D14 / 6D15
 MC811879/475-03423



FUSO
6D16
 MC092059 / 475-03479



FUSO
6D22T
 MC803817



FUSO
320 / 8DC91
 MC826183 / 475-03520



NISSAN
RD8
 14670-97014 - 475-03027



NISSAN
CK12 / CKA12
 475-04212 / 14720-95003



NISSAN
CW54 (L) / RF8
 14670-97178
 475-97361



NISSAN
CW520 (L)/RF8
 14670-97312



NISSAN
CW520 (R)/RF8
 14670-96264

RF8
 14670-97163 / 475-03332



HINO
EF750
 44300-1641



HINO
HO7C
 44310-1880 / 44310-1930



HINO
EH700
 44310-1791 / 44310-1990

HYDRAULIC PUMP SYSTEM

HYDRAULIC PUMP SYSTEM

ONIH



EK100
44310-1490

EK100
44310-1621

ONIH



ED100 (R)
44310-1430

ED100 (L)
44310-1200

ONIH



J08C (With Gear)
44310-2790

ISUZU



6BD1
475-03783 / 475-03726

ISUZU



6BG1
475-03914

ISUZU



6QA1
475-03862

ISUZU



6HE1
1-19500-584-0
470-04148



COOLER

ISUZU

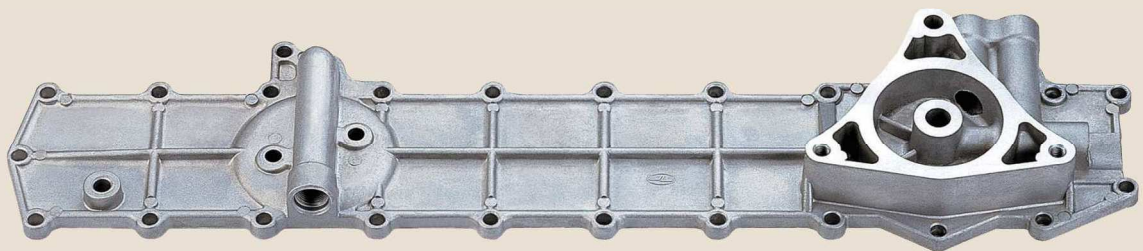

6D15 Cover Oil Cooler
ME034573

HYDRAULIC PUMP CARTRIDGE

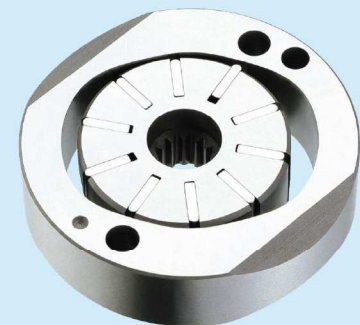
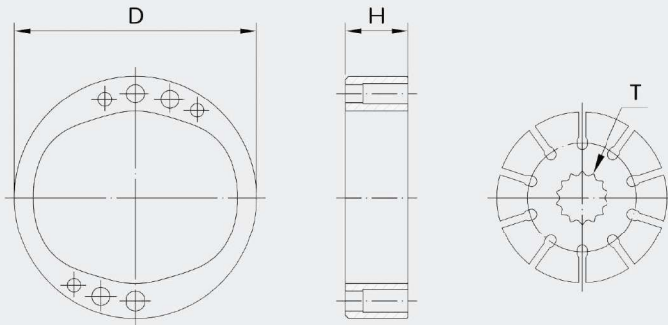

正廠號碼 Part No.	尺寸 / Dimension			適用車種 Models
	外徑 (D)	高度 (H)	齒數 (T)	
431-11127	64	12	18	太子用
14714-99100	64	23	18	UD340/EK100 (oid)/JO8C
14714-Z9005	64	18	18	—
14714-Z9009	64	14	18	—
14714-99011	92.65	19	14	PD6
14714-99012	92	16	10	PE6
14714-99017	64	28	18	CW520 / CW54 / RE8
14714-99018	64	28	10	—
44306-1030	68	16	10	ED200
44306-1060 44306-1180	64.5	16	14	EH700 / HO7C
44306-1090	68	20	10	ED100 / ZM
44306-1100	68	20	18	EF500 / EX100
44306-1150	64	20	18	EX100
44306-1160	64	16	18	—
44306-1170	64	20	18	EF750
457-10054	65	12	10	—
475-10053 475-10055	65	14	10	—
475-10056	65	16	10	堆高機
475-10057 14714-Z9004	65	18	10	6D16 / CK12
475-10050 475-10058	65	21	10	RD / CK20 / 6D14 / 6D15
475-10063 1-19519135-0	65	24	10	ISUZU V10 / 6BG1 / 6QA1 / 8DC9
475-10065	64	30	18	—
7673860153	64.5	19.57	14	BENZ
1-19519303-0	54	14	14	6HE1
470-10059	54	16	14	6HH1
	65	30	10	RF8

WATER PUMP SYSTEM



FUSO

FK416 / 6D15
ME075049



FUSO

FK457 / 6D16 6D17
ME075218



FUSO

FV419 / 8DC9 / 8DC11 / 355
ME095166 / ME092267



FUSO

FP418 / 6D22
ME055436



FUSO

FP418DRL / 6D22T
ME150295 / ME151391



ONIH

SH / MBS / EF750
16100-2952 / 16100-2262

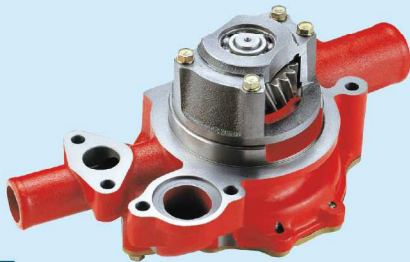

ONIH

EK100
16110-3122

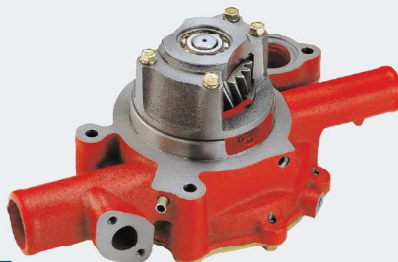

ONIH

SH331 / K13C
16100-3112



ONIH

HO7D
16100-2980 (91-93")
16100-3172 (94")



ONIH

MFG / HO6CT
16100-2660



ONIH

MGH / HO7C
16100-2640



ONIH

HO7D (W/O Case)
16100-2971 (91-93")
16100-3170 (94")

WATER PUMP SYSTEM

KOMATSU



4D95S
6204-61-1302
D20A-6 / D20P-6 D21A-6 / D21P-6

CUMMINS



ISB6.7
ISB4.5
4891252

FUSO



S6K
MD015041 / MD013409
MD013865 / ME996862

WATER PUMP SYSTEM

PUMP SYSTEM



JO8C2
15110-2030E



JO8C3
S4130-E0010



JO8C
15110-2150

PUMP SYSTEM

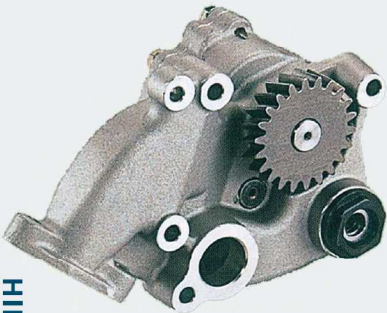

ONIH

EM100 Oil Pump
15110-1471

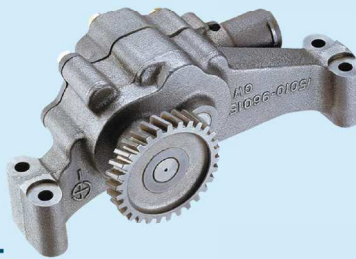

ONIH

PD6 Oil Pump
15010-96015



JO8C
1511-E0020 15110-EW010



GT3576DL



JO8C

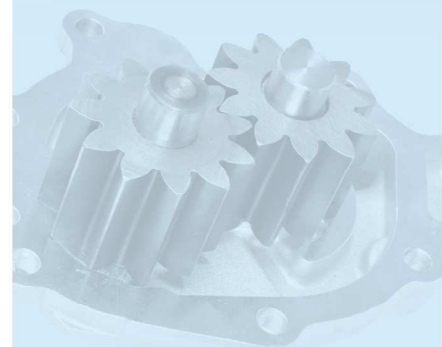

CLUTCH BOOSTER SYSTEM

CLUTCH BOOSTER SYSTEM

FUSO 320



Clctch Master
FUSO 320 : ME660596

FUSO FV



Clctch Master
FUSO FV : 03240-46002

HINO



Clctch Master
HINO : 31420-1410

NISSAN



Clctch Master
NISSAN : 46801-00Z05

ISUZU



Clctch Master
ISUZU : 1-47500231-0

FUSO 320



Clctch Booster
Big: 642-03552 Small: 642-03087

BRAKE SYSTEM

BRAKE SYSTEM

HINO



Adjuster
HINO : 47480-1590

HINO



Adjuster
HINO (RH) : 47480-1580
(LH) : 47490-1100

NISSAN



Adjuster
NISSAN (RH) : 44341-90210
(LH) : 44342-90178

NISSAN



Adjuster
NISSAN : 44341-90177

HINO



Exhaust Brake Valve
HINO : 17470-2221

FUSO



Exhaust Brake Valve
FUSO : ME090048

AIR BRAKE VALVE

FUSO 320



Drain Cock Valve
FUSO 320 : MC817017

FUSO 265



Drain Cock Valve
FUSO 265 : MC803504

HINO



Drain Cock Valve
HINO : 44850-1030

ISUZU

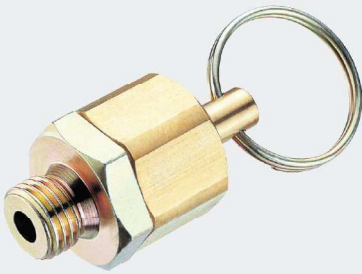

Drain Cock Valve
ISUZU : 1-48312-004-1

NISSAN

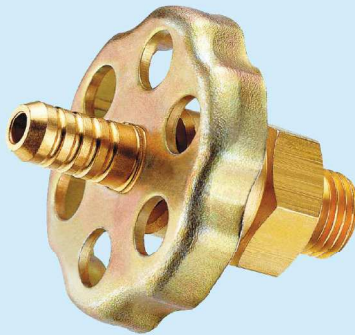

Drain Cock Valve
NISSAN : 47502-2000

Safety Valve
MC820238



Check Valve
44510-1090



Check Valve
44510-1190



FUSO/NISSAN

Double Check Valve
FUSO : MC820241
NISSAN : 45201-Z0000



FUSO/ISUZU



Double Check Valve
FUSO : MC821909
NISSAN : 1-48460-173-0

FUSO



Double Check Valve
FUSO 350 : MC886775

FUSO/NISSAN

Quick Release Valve
FUSO : 03342-56000
NISSAN : 45151-Z0001



AIR BRAKE SYSTEM

NISSAN/ISUZU



Two Ways Valve (173)
NISSAN : 26335-Z2000
ISUZU : 1-82563-029-0

FUSO



Three Ways Valve (102)
FUSO : MC840051

FUSO/NISSAN

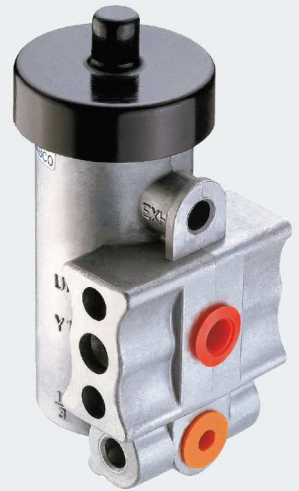

Air Governor
FUSO :
MC808718 (7.8~8.2 kg/cm²)
NISSAN :
47540-Z0005 (6.8~8.0 kg/cm²)
47540-90061 (7.2~8.5 kg/cm²)

HINO



Air Regulator
HINO :
44530-1110 (7.0~8.5 kg/cm²)
44530-1160 (6.5~8.5 kg/cm²)
44530-1170 (6.5~7.5 kg/cm²)
44530-1180 (6.0~7.5 kg/cm²)

HINO K13C



Air Regulator
HINO K13C :
44530-1321 (7.0~8.5 kg/cm²)
44530-1340 (7.5~9.0 kg/cm²)
44530-1360 (7.5~8.5 kg/cm²)

HINO



Control Valve
HINO : 47930-1070

FUSO/NISSAN



Maxi Brake Valve
FUSO : MC804585
NISSAN : 45260-Z2000

FUSO/NISSAN



Maxi Brake Valve
FUSO : 03342-14000
NISSAN : 45260-Z0000

ISUZU



Control Valve (New Type)
ISUZU : 1-48460-198-0

ISUZU



Control Valve (Old Type)
ISUZU : 1-48460-145-0

FUSO/NISSAN/ISUZU



Brake Valve
ISUZU : 241-02120 / MC807291
NISSAN : 45101-Z2003
ISUZU : 1-48100733-0

AIR BRAKE SYSTEM



Drain Bearing
4D56 / L300 : MR185920

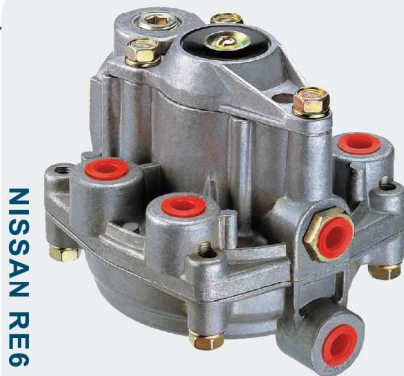

NISSAN RE6

Relay Valve
NISSAN RE6 : 454-000-3030



FUSO

Control Cylinder
FUSO : ME063715

AIR BRAKE VALVE

AIR COMPRESSOR SYSTEM



ISUZU V10

Air Compressor Head
ISUZU V10 : 1-1911018-1



HINO EF750

Air Compressor Head
ISUZU EF750 : 29110-1252



HINO K13C

Air Compressor Head
HINO K13C : 29110-1536



HINO F17C

Air Compressor Head
HINO F17C : 29110-1424



正廠號碼 Part No.	I/E	備註 Note	適用車種 Models
29103-1020 29103-1010 30975-01070	IN	空壓機進氣上部活門 (銅)	320 / 8DC9 / RK / EH700
29103-1081 14550-99003	IN	空壓機進氣上部活門 (鐵)	
29103-1081	IN	空壓機進氣上部活門 (雙層)	EF750
29103-1121 29103-1152	IN	空壓機進氣上部活門 雙層(小孔)	F17C / F20C
29103-1140 29103-1142	IN	空壓機進氣上部活門 雙層(大孔)	K13C

AIR COMPRESSOR SYSTEM

AIR COMPRESSOR KIT



EX (with nut)



EX



IN



**Air Dryer Release Kit
Wabco Release Kit**

正廠號碼 Part No.	I / E	備 註 Note	適用車種 Models
ME713161 29101-1161	IN		6D14 / 6D15 / 6D16
ME713162	EX		
ME048010 ME067030	EX IN		8DC4 / 8DC8 / FV265 / FV310
30975-02070 29101-1120	IN		8DC91 / 8DC11 / FP-415 FV-415 / 320 / 355
30975-02060 29102-1120	EX	With nut	
29101-1070 29101-1170 14570-99025	IN		EF750 / F17C / K13C / EK100 UD340 / UD300 / UD8
29102-1070 29102-1180	EX		EF750 / KB / EK100 / LSH
29102-1330	EX		
29102-1200 14569-99025	EX	With nut	EF750
29102-1270	EX	With nut	F17C / K13C / F20C / LSH350
29101-1040 29101-1160 (N) 14570-99028	IN		EN / EK100 / K13D/ MGH15T / LRK
29102-1040 29102-1340 14570-99026	EX		
29102-1290	EX	With nut	
29101-1050 29101-1220	IN		RK / EH700
29102-1050 29102-1300	EX		
29102-1220	EX	With nut	
29101-1160	IN		EF500
29121-1030	EX	With nut	阿爾及利亞訂作
AD0202-5			ISB6.7

汽車零件
渦輪增壓器
油壓動力組件

Parts For Automobile
Turbocharger Assy
Parts For Oil Hydraulic Pump



喬晟股份有限公司
CHIAU CHENG CO., LTD.

志昇工廠企業有限公司
CHIH SHENG FACTORY CO., LTD

540 南投市彰南路一段723號
No.723, Sec. 1, Chang-nan Rd., Nantou 540, Taiwan, R.O.C

TEL:+886-49-2222-456
FAX:+886-49-2229-908

E-mail:chchcl@ms23.hinet.net
<http://www.chshturbo.com.tw>

